

DS90LV027A

LVDS Dual High Speed Differential Driver

General Description

The DS90LV027A is a dual LVDS driver device optimized for high data rate and low power applications. The device is designed to support data rates in excess of 600Mbps (300MHz) utilizing Low Voltage Differential Signaling (LVDS) technology. The DS90LV027A is a current mode driver allowing power dissipation to remain low even at high frequency. In addition, the short circuit fault current is also minimized.

The device is in a 8-lead small outline package. The DS90LV027A has a flow-through design for easy PCB layout. The differential driver outputs provides low EMI with its typical low output swing of 360 mV. It is perfect for high speed transfer of clock and data. The DS90LV027A can be paired with its companion dual line receiver, the DS90LV028A, or with any of National's LVDS receivers, to provide a high-speed point-to-point LVDS interface.

Features

- >600 Mbps (300MHz) switching rates
- 0.3 ns typical differential skew
- 0.7 ns maximum differential skew
- 1.5 ns maximum propagation delay
- 3.3V power supply design
- ± 360 mV differential signaling
- Low power dissipation (46 mW @ 3.3V static)
- Flow-through design simplifies PCB layout
- Interoperable with existing 5V LVDS devices
- Power Off Protection (outputs in high impedance)
- Conforms to TIA/EIA-644 Standard
- 8-Lead SOIC package saves space
- Industrial temperature operating range (-40°C to $+85^{\circ}\text{C}$)

Connection Diagram

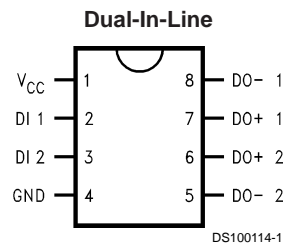

Order Number DS90LV027ATM
See NS Package Number M08A

Functional Diagram

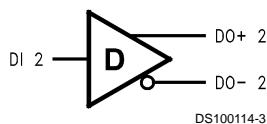
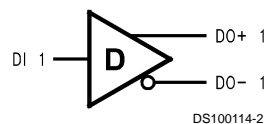

Absolute Maximum Ratings (Note 1)

If Military/Aerospace specified devices are required, please contact the National Semiconductor Sales Office/Distributors for availability and specifications.

Supply Voltage (V_{CC})	-0.3V to +4V
Input Voltage (DI)	-0.3V to +3.6V
Output Voltage (DO \pm)	-0.3V to +3.9V
Maximum Package Power Dissipation @ +25°C	
M Package	1190 mW
Derate M Package	9.5 mW/°C above +25°C
Storage Temperature Range	-65°C to +150°C
Lead Temperature Range Soldering (4 sec.)	+260°C

ESD Ratings

(HBM 1.5 k Ω , 100 pF)	≥ 8 kV
(EIAJ 0 Ω , 200 pF)	≥ 1000 V
(CDM)	≥ 1000 V
(IEC direct 330 Ω , 150 pF)	≥ 4 kV

Recommended Operating Conditions

	Min	Typ	Max	Units
Supply Voltage (V_{CC})	3.0	3.3	3.6	V
Temperature (T_A)	-40	25	+85	°C

Electrical Characteristics

Over Supply Voltage and Operating Temperature ranges, unless otherwise specified. (Notes 2, 3, 7)

Symbol	Parameter	Conditions	Pin	Min	Typ	Max	Units	
DIFFERENTIAL DRIVER CHARACTERISTICS								
V_{OD}	Output Differential Voltage	$R_L = 100\Omega$ (Figure 1)	DO+, DO-	250	360	450	mV	
ΔV_{OD}	V_{OD} Magnitude Change				1	35	mV	
V_{OH}	Output High Voltage				1.4	1.6	V	
V_{OL}	Output Low Voltage				0.9	1.1	V	
V_{OS}	Offset Voltage				1.125	1.2	1.375	V
ΔV_{OS}	Offset Magnitude Change				0	3	25	mV
I_{OXD}	Power-off Leakage	$V_{OUT} = V_{CC}$ or GND, $V_{CC} = 0$ V			± 1	± 10	μ A	
I_{OSD}	Output Short Circuit Current				-5.7	-8	mA	
V_{IH}	Input High Voltage		DI	2.0		V_{CC}	V	
V_{IL}	Input Low Voltage			GND		0.8	V	
I_{IH}	Input High Current	$V_{IN} = 3.3$ V or 2.4V				± 2	± 10	μ A
I_{IL}	Input Low Current	$V_{IN} =$ GND or 0.5V				± 1	± 10	μ A
V_{CL}	Input Clamp Voltage	$I_{CL} = -18$ mA			-1.5	-0.6		V
I_{CC}	Power Supply Current	No Load	$V_{IN} = V_{CC}$ or GND	V_{CC}		8	14	mA
		$R_L = 100\Omega$				14	20	mA

Switching Characteristics

Over Supply Voltage and Operating Temperature Ranges, unless otherwise specified. (Notes 3, 4, 5, 6)

Symbol	Parameter	Conditions	Min	Typ	Max	Units	
DIFFERENTIAL DRIVER CHARACTERISTICS							
t_{PHLD}	Differential Propagation Delay High to Low	$R_L = 100\Omega$, $C_L = 15$ pF (Figure 2 and Figure 3)	0.3	0.8	1.5	ns	
t_{PLHD}	Differential Propagation Delay Low to High		0.3	1.1	1.5	ns	
t_{SKD1}	Differential Pulse Skew $ t_{PHLD} - t_{PLHD} $ (Note 8)		0	0.3	0.7	ns	
t_{SKD2}	Channel to Channel Skew (Note 9)		0	0.4	0.8	ns	
t_{SKD3}	Differential Part to Part Skew (Note 10)		0		1.0	ns	
t_{SKD4}	Differential Part to Part Skew (Note 11)		0		1.2	ns	
t_{TLH}	Transition Low to High Time		0.2	0.5	1.0	ns	
t_{THL}	Transition High to Low Time		0.2	0.5	1.0	ns	
f_{MAX}	Maximum Operating Frequency (Note 12)				350		MHz

Note 1: "Absolute Maximum Ratings" are those values beyond which the safety of the device cannot be guaranteed. They are not meant to imply that the devices should be operated at these limits. The table of "Electrical Characteristics" specifies conditions of device operation.

Note 2: Current into device pins is defined as positive. Current out of device pins is defined as negative. All voltages are referenced to ground except V_{OD} .

Note 3: All typicals are given for: $V_{CC} = +3.3$ V and $T_A = +25^\circ$ C.

Note 4: These parameters are guaranteed by design. The limits are based on statistical analysis of the device over PVT (process, voltage, temperature) ranges.

Note 5: C_L includes probe and fixture capacitance.

Note 6: Generator waveform for all tests unless otherwise specified: $f = 1$ MHz, $Z_0 = 50\Omega$, $t_r \leq 1$ ns, $t_f \leq 1$ ns (10%-90%).

Switching Characteristics (Continued)

Note 7: The DS90LV027A is a current mode device and only function with datasheet specification when a resistive load is applied to the drivers outputs.

Note 8: t_{SKD1} , $|t_{PHLD} - t_{PLHD}|$, is the magnitude difference in differential propagation delay time between the positive going edge and the negative going edge of the same channel.

Note 9: t_{SKD2} is the Differential Channel to Channel Skew of any event on the same device.

Note 10: t_{SKD3} , Differential Part to Part Skew, is defined as the difference between the minimum and maximum specified differential propagation delays. This specification applies to devices at the same V_{CC} and within 5°C of each other within the operating temperature range.

Note 11: t_{SKD4} , part to part skew, is the differential channel to channel skew of any event between devices. This specification applies to devices over recommended operating temperature and voltage ranges, and across process distribution. t_{SKD4} is defined as $|Max - Min|$ differential propagation delay.

Note 12: f_{MAX} generator input conditions: $t_r = t_f < 1$ ns (0% to 100%), 50% duty cycle, 0V to 3V. Output criteria: duty cycle = 45%/55%, $V_{OD} > 250$ mV, all channels switching.

Parameter Measurement Information

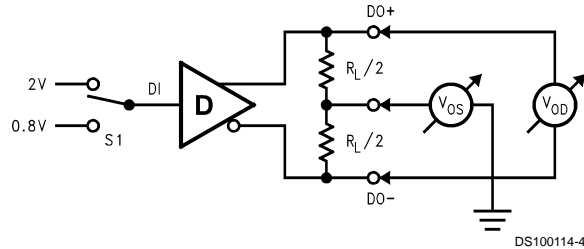

FIGURE 1. Differential Driver DC Test Circuit

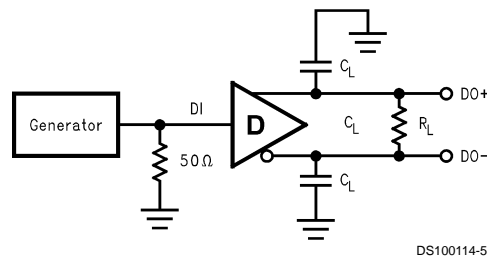

FIGURE 2. Differential Driver Propagation Delay and Transition Time Test Circuit

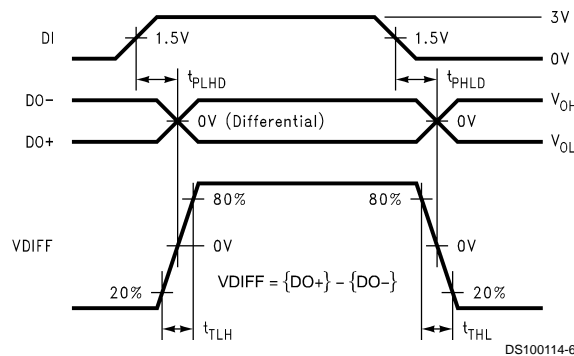

FIGURE 3. Differential Driver Propagation Delay and Transition Time Waveforms

Application Information

TABLE 1. Device Pin Descriptions

Pin #	Name	Description
2, 3	DI	TTL/CMOS driver input pins
6, 7	DO+	Non-inverting driver output pin
5, 8	DO-	Inverting driver output pin
4	GND	Ground pin
1	V_{CC}	Positive power supply pin, $+3.3V \pm 0.3V$

Typical Performance Curves

Output High Voltage vs Power Supply Voltage

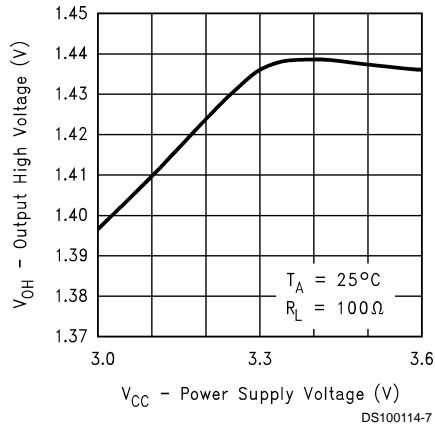

Output Low Voltage vs Power Supply Voltage

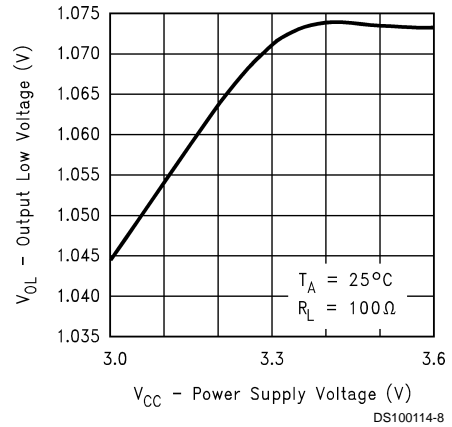

Output Short Circuit Current vs Power Supply Voltage

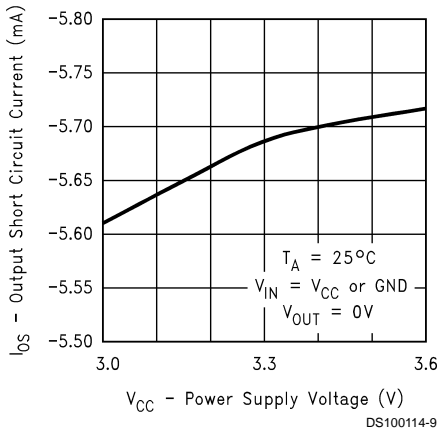

Differential Output Voltage vs Power Supply Voltage

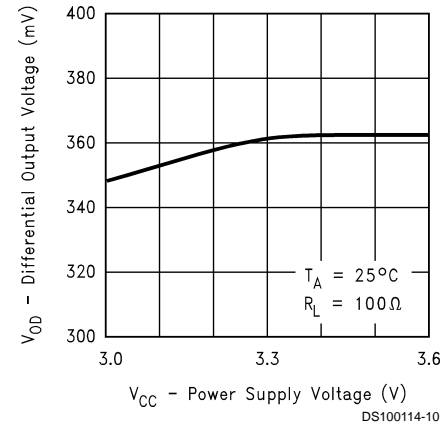

Differential Output Voltage vs Load Resistor

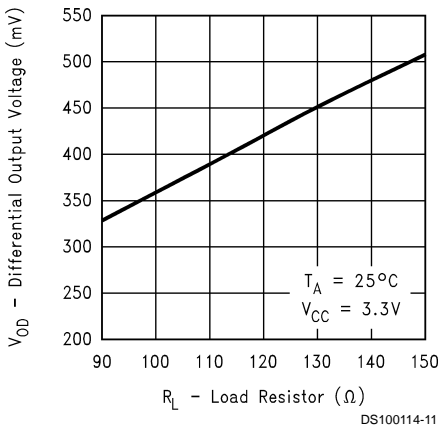

Offset Voltage vs Power Supply Voltage

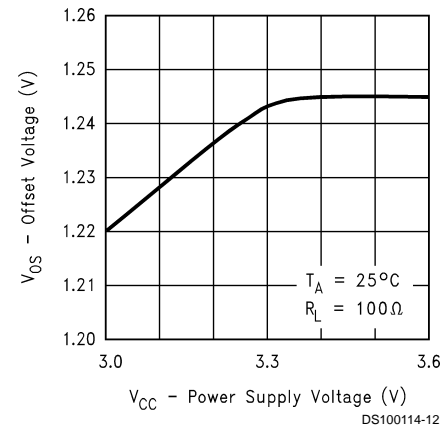

Typical Performance Curves (Continued)

Power Supply Current vs Frequency

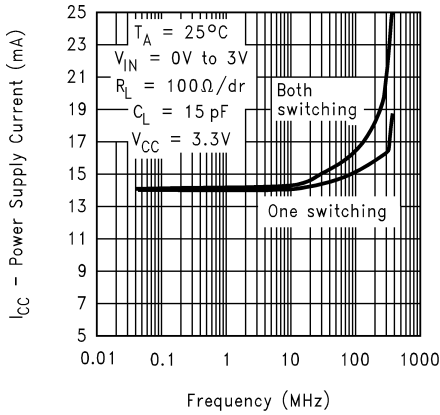

Power Supply Current vs Power Supply Voltage

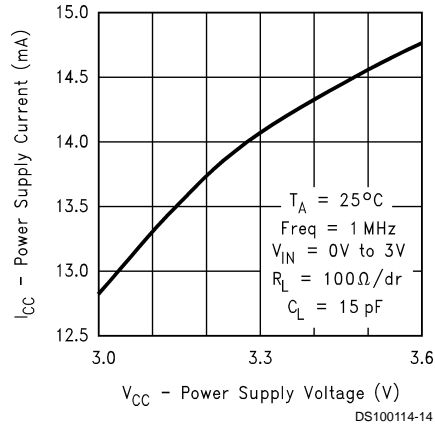

Power Supply Current vs Ambient Temperature

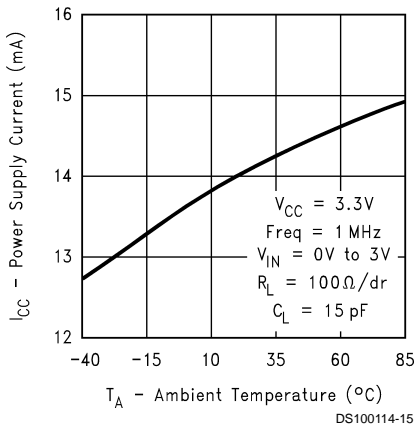

Differential Propagation Delay vs Power Supply Voltage

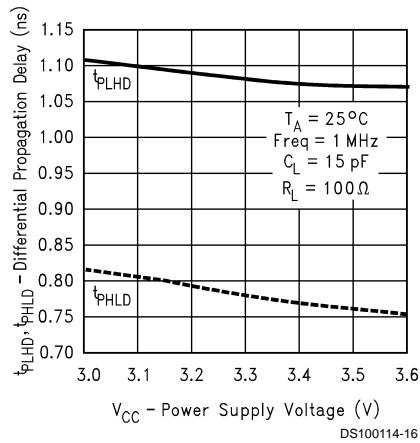

Differential Propagation Delay vs Ambient Temperature

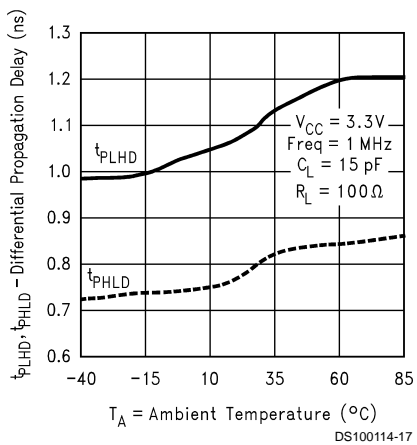

Differential Skew vs Power Supply Voltage

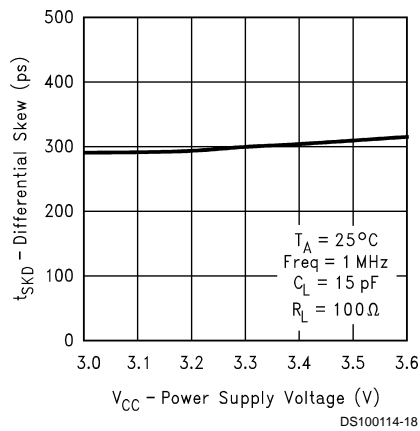

Typical Performance Curves (Continued)

Differential Skew vs Ambient Temperature

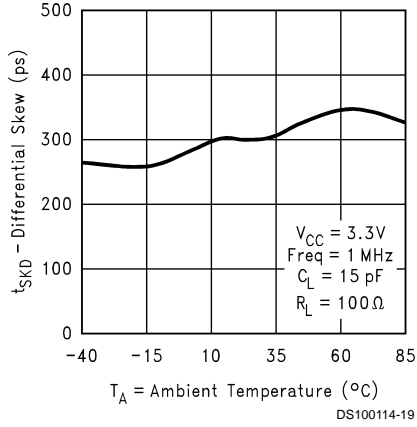

Transition Time vs Power Supply Voltage

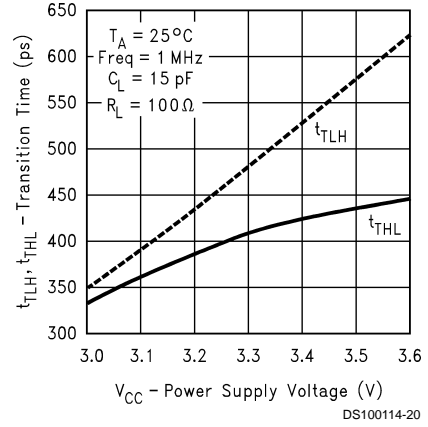

Transition Time vs Ambient Temperature

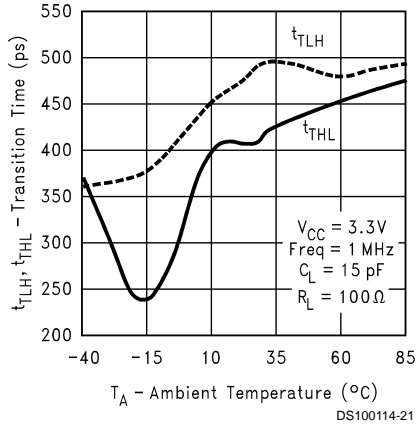

Physical Dimensions inches (millimeters) unless otherwise noted

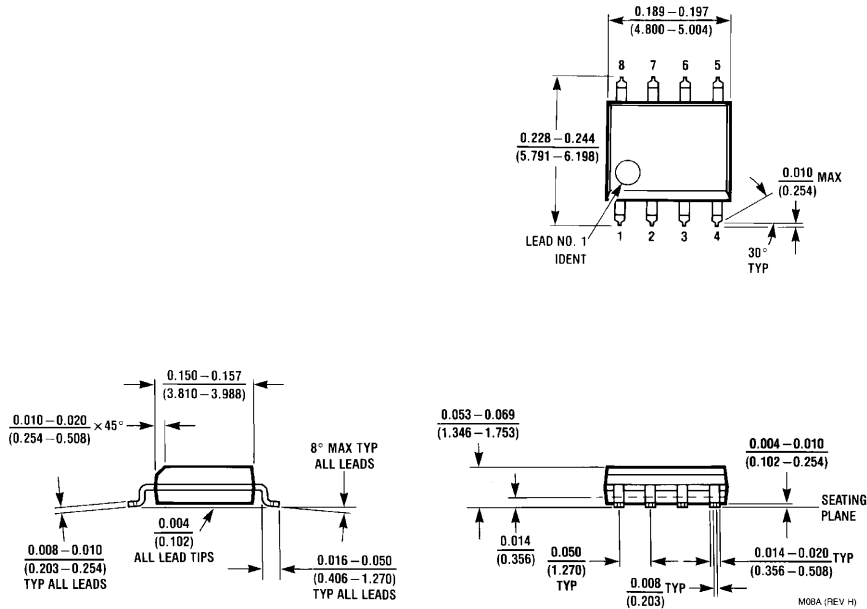

Order Number DS90LV027ATM
NS Package Number M08A

LIFE SUPPORT POLICY

NATIONAL'S PRODUCTS ARE NOT AUTHORIZED FOR USE AS CRITICAL COMPONENTS IN LIFE SUPPORT DEVICES OR SYSTEMS WITHOUT THE EXPRESS WRITTEN APPROVAL OF THE PRESIDENT AND GENERAL COUNSEL OF NATIONAL SEMICONDUCTOR CORPORATION. As used herein:

1. Life support devices or systems are devices or systems which, (a) are intended for surgical implant into the body, or (b) support or sustain life, and whose failure to perform when properly used in accordance with instructions for use provided in the labeling, can be reasonably expected to result in a significant injury to the user.
2. A critical component is any component of a life support device or system whose failure to perform can be reasonably expected to cause the failure of the life support device or system, or to affect its safety or effectiveness.



National Semiconductor Corporation
Americas
Tel: 1-800-272-9959
Fax: 1-800-737-7018
Email: support@nsc.com
www.national.com

National Semiconductor Europe
Fax: +49 (0) 180-530 85 86
Email: europe.support@nsc.com
Deutsch Tel: +49 (0) 69 9508 6208
English Tel: +44 (0) 870 24 0 2171
Français Tel: +33 (0) 1 41 91 8790

National Semiconductor Asia Pacific Customer Response Group
Tel: 65-2544466
Fax: 65-2504466
Email: ap.support@nsc.com

National Semiconductor Japan Ltd.
Tel: 81-3-5639-7560
Fax: 81-3-5639-7507